

CALIBRATION OF THREE COMMON FLOW MEASUREMENT DEVICES FOR OPEN CHANNELS

M.Y. El-Ansary¹ M.A. Awad² A.A. Nassar³ A.A. Farag⁴

ABSTRACT

The aim of this research was to test and calibrate some water flow measurement devices, which were appropriate for on-farm management in Egypt. To fulfill this purpose, three of the common water- flow measurement devices (v-notch, rectangular weir and cutthroat flume) were calibrated in the Laboratory of Hydraulics Research Institute in Qanater City (Egypt, القناطر). The calibration was carried out using an ultrasonic flow- meter.

Results of this study showed that under low discharges, i.e. 5 and 10 Ls⁻¹, the most accurate device was the v-notch, under high discharges 15, 20, 25, 30 and 35 L s⁻¹, the most accurate one was the rectangular weir. Increasing discharge rate from 5 to 35 L s⁻¹ resulted in increases in error percentage in the readings of the v-notch. On the other hand, the corresponding error percentages in readings of both the rectangular weir and the cutthroat flume were obviously decreased. The decreases seemed inversely related to the increase in rate of discharge. Effect of time interval on error percentage seemed to be irregular. From the aforementioned results, it could be deduced that the v-notch weir is preferable for measuring the discharge at a rate ranging from 5 to 10 L s⁻¹, beyond which the rectangular weir, as well as the cutthroat flume, would be preferable.

INTRODUCTION

The ultimate goal of water measurement is to conserve water through improving management of distribution and application. Attention to measurement, management, and maintenance will take advantage of the farmer's water and help prevent reduced yields and other crop damage caused by under or over watering (**Pugh, 2001**).

1;2;4 Resp. Prof. Emt.; Assoc. Prof.; and Teaching Assist., Ag. Eng. Dept., Fac. Ag., Benha U., and

3 Assoc.Prof. Water Mang. And Irrig. Sy. Res. Ins., WMISRI , MWRI.

Flow measuring devices are commonly classified into those that sense velocity and those that measure pressure or head. The head or velocity is measured, and then charts, tables, or equations are used to obtain the discharge. Some water measuring devices use measurement of head, h , or pressure, p , to determine discharge, Q , including weirs, flumes, orifices, and venturis and take measurement on a flat "weir stick". Head, h , or depth is used for the open channel devices such as flumes and weirs. Pressure, p , or head, h , is used with tube-type flow meters such as venturi. Some devices actually measure velocities, v , including: float and stopwatch, current and propeller meters and vane deflection meters (**USBR, 2001**).

1a: Weirs

The weir is a notch of a specific shape through which water may flow. It requires enough slope in the ditch to allow the water to be partially held back and spill over the weir. Air space is necessary under the falling sheet of water for accurate flow measurement (**Replogel, 1998**).

1b: Flumes

The cutthroat flume with its level floor and simple inlet and exit is easy to construct and install in almost any field situation. Fabrication errors are not serious as the ratings are easily adjusted.

The flumes are designed to cause enough pounding to avoid the submerged-flow range. On existing canals already running to capacity, this pounding would require increasing the up-stream freeboard (**Replogle, 1971**). Flumes and weirs with submerged (non-modular or drowned) flows are not recommended for measuring discharge. The principal requirement for either the weirs or flumes is that the constricted section be sufficiently long that the streamlines become parallel. Then, theory can be used to predict the free flow discharge within $\pm 5\%$ error (**Bos, et al., 1985**).

The rectangular weir is the most commonly used thin plate. Weirs are typically installed in open channels such as streams to determine discharge (flow rate). The basic principle is that discharge is directly related to the water depth (h) above the crest. Rectangular weirs can be "suppressed," "partially contracted," or "fully contracted." Suppressed means that there are no contractions. A suppressed weir's notch width (b) is equal to the channel width. Thus, there really is no notch - the weir is

flat all the way along the top. Weir contractions cause the water flow lines to converge through the notch (**USBR, 2001**).

Free flow occurs when a hydraulic jump is visible at the throat; that is, when the downstream head is significantly less than the upstream head. (**LMNO Engineering, 2001**).

The **objectives of this research** were evaluating water flow measurement devices appropriate for on-farm irrigation management in Egypt. To achieve these objectives, three different devices were tested in the Hydraulic Research Institute, NWRC, MWRI, at EL-Qanater (القناطر), Egypt during 2005-2006.

MATERIALS AND METHODS.

2a: Water flow measuring devices.

Three different devices (v-notch, rectangular weir and cutthroat flume) were tested and calibrated to select the most appropriate one. Open channel for testing was built from masonry and lined by mortar, with dimensions of 10 m (length) \times 0.72 m (width) \times 0.45 m (depth) as shown in Fig (1). (**Farag,2007**)

Horizontal centrifugal pump was used to deliver different flow rates under different heads (35 L/s, 11.19 kW, at 1485 rpm). The required discharge was controlled by 4" (10 cm) gate valve.

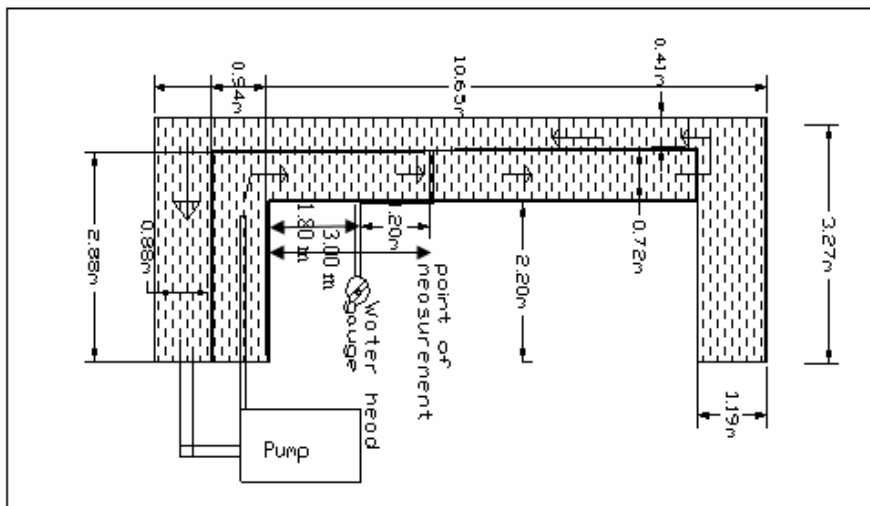

Figure (1): Schematic diagram of open channel measurement station.

2b: V-notch

The notch was made of wood and painted to protect weir from water. The specifications of weir are as follows: the angle of notch is 90 degrees, the top of the crest is 1.5 mm to 2 mm. The thickness was chamfered in the downstream edge of the crest and sides to an angle of 45 degrees, the height of crest is 16.5 cm above floor, height of weir shoulder is 43.5 cm, and floor width is 71.5 cm, as shown in Figures (2) and (3).



Figure (2): V-notch weir.

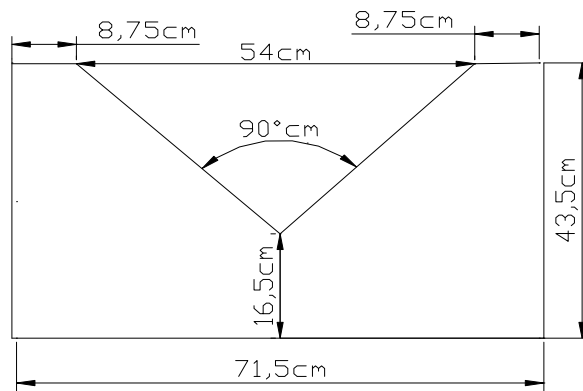

Figure (3): Diagram of v-notch weir

The Kindsvater-Shen equation was used for fully constricted notches of any angle between 25 degrees and 100 degrees (**Kulin and Compton, 1975**).

The equation which includes the angle θ as a variable is written as:

$$Q = 0.121 C_e \tan\left(\frac{\theta}{2}\right) h_{le}^{\frac{5}{2}} \quad (5)$$

Where:

Q = discharge over weir in m^3/s ,

C_e = effective discharge coefficient ($0.578 \text{ m}^{1/2}\text{s}^{-1}$),

h_1 = head on the weir in m,

$h_{1e} = h_1 + k_h$ in m,

θ = angle of v-notch,

k_h = The head correction factor (0.001 m). (USBR, 2001) and ASTM (2003).

v-notch weir was fixed at distance 3 m from the pump delivery pipe as shown in Figure (1). Spirit level was used to make the v-notch weir vertical with flow direction and floor of the channel.

Upstream head gauge was fixed at a distance of 120 cm from v-notch weir. Spirit level was used to make gauge vertical. The head gauge was not used in downstream because the flow was free.



Figure (4): Rectangular weir.

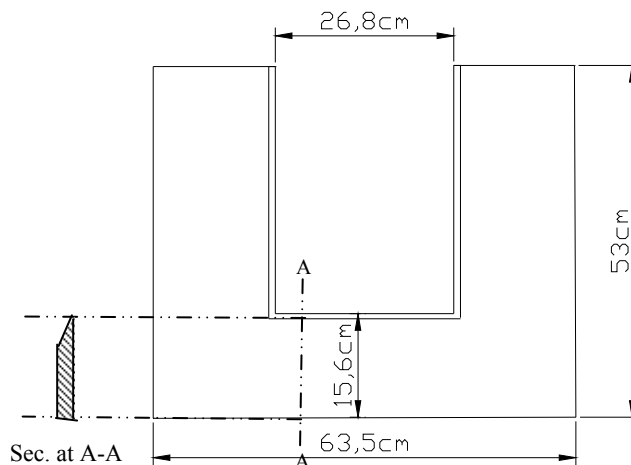

Figure (5): Rectangular weir.

2c: Rectangular weir

The weir was made of wood and painted against water. The specifications of this weir were: height 53 cm, height of crest 15.6 cm, the crest width 26.8 cm, and width of weir is 63.5cm as shown in Figures (4 and 5).

The basic equation of the Kindsvater-Carter (USBR, 2001) and (ASTM, 2003):

$$Q = C_e L_e h_{1e}^{3/2} \quad (6)$$

Where:

Q = discharge (m^3/s)

e = a subscript denoting "effective"

C_e = effective coefficient of discharge, $\text{m}^{1/2}/\text{s}$

$C_e = C_1(h_1/p) + C_2$ $C_1 = 0.008$, $C_2 = 0.294$

$L_e = L + k_b$

$h_{1e} = h_1 + k_h$

In these relationships:

k_b = a correction factor to obtain effective weir length (0.003)

L = measured length of weir crest

B = average width of approach channel, m

h_1 = head measured above the weir crest, m

k_h = a correction factor with a value of 0.001 m

A rectangular weir was fixed at a distance of 3 m from the delivery pipe as shown in Figure (1). Spirit level was used to make rectangular weir vertical on flow direction and floor of the channel as shown in Figure (6).



Figure (6): Rectangular weir in vertical direction.

Upstream head gauge was fixed at a distance of 120 cm from the rectangular weir as shown in Fig. (1). Spirit level was used to make gauge vertical. Downstream head gauge was not used because flow was free.

2d: Cutthroat flume

This flume is a simple device made of fiberglass, whose specifications are as follows:

Height of the cutthroat flume is 47 cm,

Width of throat is 10 cm,

Flume length is 90cm,

The width of approach in channel is 40 cm.

The upstream head gauge was fixed at a distance of 20 cm from throat of flume as pointed in Figure (7).

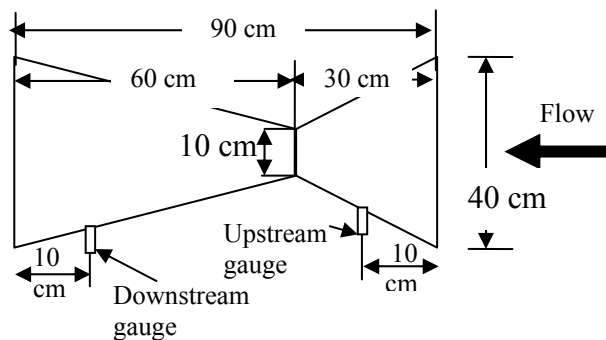

Figure (7): Cutthroat flume.

The basic discharge equation for cutthroat flumes is:

$$Q = C_f h_u^{n_f} \quad (7)$$

Where,

Q = the discharge in m^3/sec ;

h_u = the upstream gauge reading in meters;

C_f = the 'free flow' coefficient; and = 1.476,

n_f = the 'free flow' exponent, = 1.5 from figure (8) (Walker, 1989)

The value of n_f can be read directly from figure (8). The value of the free flow coefficient C_f , is a function of the flume's length and throat width:

$$C_f = K_f W^{1.025} \quad (3-5)$$

Where,

W = the throat width in feet; and

K_f = the flume 'length' coefficient, figure (8).

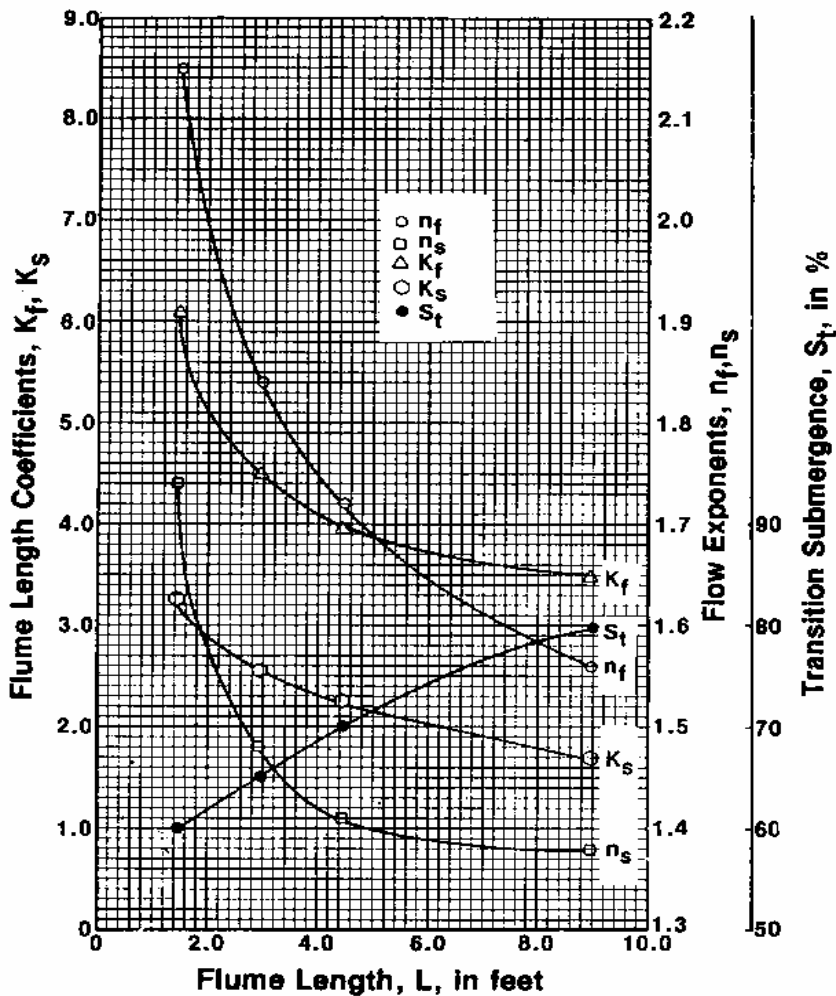

Figure (8): The cutthroat flume rating curves (Walker, 1989).

The cutthroat flume was fixed at a distance of 3 m from the delivery pipe. Spirit level was used to make cutthroat flume vertical on flow direction and the axle of device parallel to the axle of the channel flow.

The well of upstream-head gauge (0-1m) was fixed at a distance of 20 cm from the throat as shown in Fig. (7). Spirit level was used to make head gauge vertical. Downstream gauge was not used because flow was free.

2e: Ultrasonic flowmeter

Ultrasonic flowmeter is designed to measure the fluid discharge within closed conduit (pipe). The transducers are a non-contacting, clamp-on type, which provides benefits of non-fouling operation and ease of installation.

Accuracy of ultrasonic flow meter was 1% to 3% intrinsic calibration (better than 0.5 % of actual flow possible with external calibration). Flow sensitivity was 0.001 ft/sec (0.0003 m/s) – even at zero flow. zero Drift Stability was 0.003 ft/sec (0.001 m/s) for typical applications. Response rate was programmable from 0.2 to 60 seconds. Flow velocity range was ± 40 ft/sec (12 m/s minimum), including zero flow; Linearity was 0.003ft/sec (0.001 m/s) and flow profile compensation was programmable.



Figure (9): Ultrasonic flow meter.

Installation and fixation of the ultrasonic flow meter

The transducers were fixed at distance of 2.3 m from upstream direction and 0.8 cm from valve as shown in Fig. (10). Spirit level was used to make the transducer mount parallel to the suction pipe .The upstream and downstream transducers were as shown in Fig. (11).

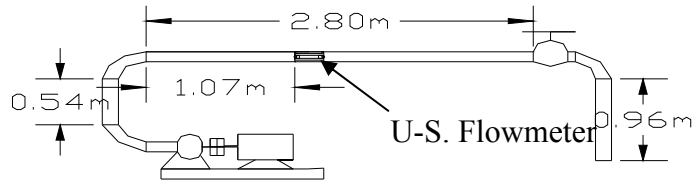

Figure (10): Setup of ultrasonic flowmeter on pipe.



Figure (11): Mounting U-S. flowmeter on steel pipe.

RESULTS AND DISCUSSION

3a: Calibration of flow measuring devices.

The measurement point was selected at a distance 3-4 m from the pump suction pipe. Head gauge was fixed upstream at distance 120 cm from the measuring point to be at 4-6 times head, max, for v-notch weir and rectangular weir (USBR, 2001). For cutthroat flume, head was measured upstream from the throat at distance of 2-3 times the length of the approach channel (MNO Engineering, 2001).

v-notch, rectangular weirs and cutthroat flume were calibrated by ultrasonic flow meter.

3b: Performance of flow-measuring devices

Measurement data of water discharge at one point of mesqa (المسقة), by using different flow measuring devices (v-notch, rectangular weir and cutthroat flume) are presented in Figures 12,13 and 14 respectively.

Under discharges 5 to 10 Ls^{-1} , the v-notch gave the highest accuracy, with errors in percent full-scale discharge between -1.51%, and 2.87%, respectively. Under discharges of 15 to 25 Ls^{-1} , the rectangular weir gave

highest accuracy because the errors in full-scale discharge were -1.8%, -1.58%, and -1.16% respectively. Under 30 L s^{-1} , the cutthroat flume gave highest accuracy, with errors in discharge of 0.16%, -1.31% and 4.22% for cutthroat flume, rectangular weir and v-notch weir respectively. Under 35 L s^{-1} , the rectangular gave highest accuracy with errors in discharge of -2.49%, -2.65% and 3.41% for rectangular weir, cutthroat flume and v-notch weir respectively. The relation between head and discharge which is shown in figures (12, 13 and 14) can be presented by the following equations, to calculate the discharge for evaluated devices under the same conditions and under discharges 5 to 35 L s^{-1} . These results agree with **ASTM, (2003) and Replogle and Clemmens (1979)** from 5 to 10 L s^{-1} for v-notch weir and 15 to 35 L s^{-1} for rectangular weir and cutthroat flume.

The best equations of flow discharge were obtained from the calibration of v-notch weir, rectangular weir and cutthroat flume by using ultrasonic flowmeter under discharges 5 to 35 L s^{-1} .

For the v-notch weir:

$$Q_v = 0.0168 H^{2.4208} \quad (8)$$

$$R^2 = 0.9994.$$

For the rectangular weir:

$$Q_r = 0.5658 H^{1.4446} \quad (9)$$

$$R^2 = 0.9997.$$

For cutthroat flume:

$$Q_c = 0.1116 H^{1.7286} \quad (10)$$

$$R^2 = 0.9989.$$

Here

Q_u = discharge of ultrasonic flow meter (L s^{-1}),

Q_c = discharge of cutthroat flume (L s^{-1}),

Q_r = discharge of rectangular weir (L s^{-1}),

Q_v = discharge of v-notch weir (L s^{-1}), and

H = head of water (cm.).

3d: The error percentage in values of discharge.

The relation between the discharge and error percentage which is represented by Figure (15) is given by the following equations.

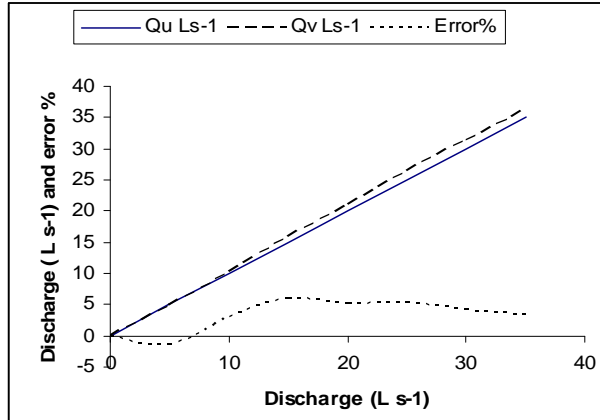

Figure (12): V-notch, performance.

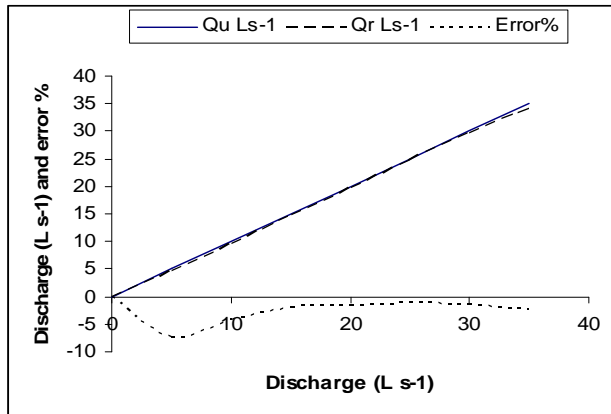

Figure (13): Rectangular weir, performance.

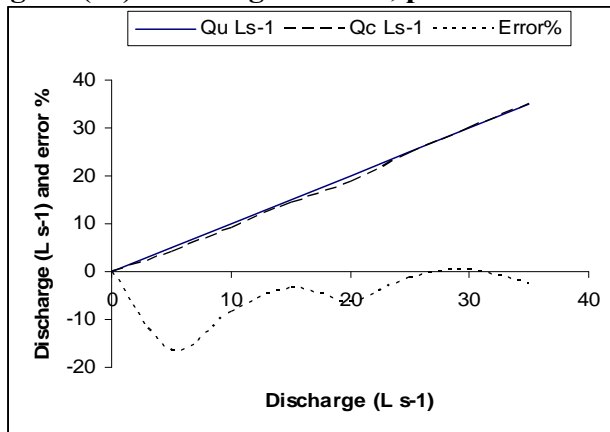

Figure (14): Cutthroat flume, performance.

The best equations of error percentage in values of discharge are obtained from the calibration of v-notch, rectangular weir and cutthroat flume by using ultrasonic flowmeter under discharges 5 to 35 L s⁻¹.

For the v-notch weir,

$$E_v\% = -0.0214 Q^2 + 0.9762 Q - 5.1714 \quad (11)$$

$$R^2 = 0.8899$$

For the rectangular weir,

$$E_r\% = -0.016 Q^2 + 0.7944 Q - 10.714 \quad (12)$$

$$R^2 = 0.9805$$

And for the cutthroat flume

$$E_c\% = 0.0097 Q^2 - 1.061 Q + 17.004 \quad (13)$$

$$R^2 = 0.9612$$

Table (4): Error percentage in reading of discharge.

Q_u	$E_v\%$	$E_r\%$	$E_c\%$
5	-1.511	-7.302	-16.568
10	2.87	-4.391	-8.362
15	6.064	-1.798	-3.445
20	5.169	-1.578	-6.378
25	5.224	-1.164	-1.174
30	4.216	-1.315	0.165
35	3.408	-2.487	-2.65

Here:

$E_r, E_v, E_c\%$ = error percentages in values of discharge for rectangular weir, v-notch; and cutthroat flume resp.

3e: Coefficient of discharge (C_d)

From data present in figures (16, 17 and 18), the coefficients of discharge for v-notch are represented by three average values: 0.585, 0.555 and 0.563, for the discharges from 5 Ls⁻¹ to 10 Ls⁻¹, 15 Ls⁻¹ to 25 Ls⁻¹ and from 30 Ls⁻¹ to 35 Ls⁻¹ respectively. The averages of the coefficients for the rectangular weir are: 0.653, 0.617 and 0.619, for the discharges from 5 Ls⁻¹ to 10 Ls⁻¹, 15 Ls⁻¹ to 30 Ls⁻¹ and from 30 to 35 Ls⁻¹ respectively.. The coefficients of discharge for cutthroat flume are 0.216, 0.238 and 0.255, for discharges from 5 Ls⁻¹ to 10 Ls⁻¹, 15 Ls⁻¹ to 25 Ls⁻¹ and from 30 Ls⁻¹ to 35 Ls⁻¹, respectively. These agree with **Cuttle and Mason, (1987) and Swamee (1988)**.

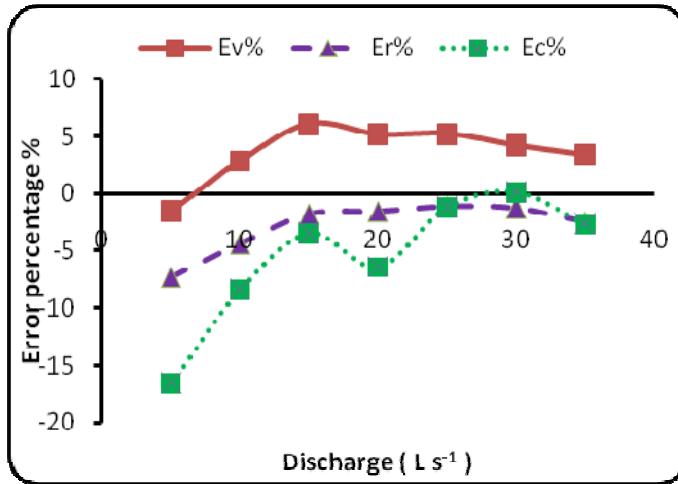

Figure (15): Error percentages under different discharges for v-notch (E_v %), rectangular weir (E_r %) and cutthroat flume (E_c %).

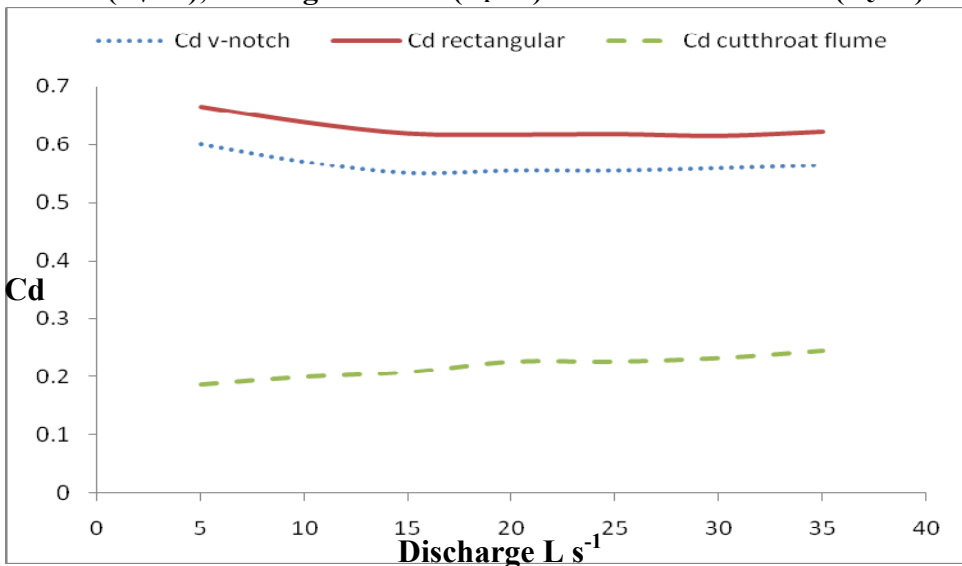

Figure (16): Coefficients of discharge for v-notch, rectangular weir and cutthroat flume.

3f: Head-discharge relation

The relation between head and discharge is shown in Fig. (19). For 5, 10 and 15 cm heads. The lowest discharge values (0.827, 4.427 and 11.814 L s⁻¹) were recorded for the v-notch. The intermediate values (1.793, 5.942 and 11.976 L s⁻¹) were recorded for cutthroat flume, whereas the

highest discharge values (5.786 , 15.749 and 28.291 L s^{-1}) were recorded for rectangular weir.

For the 20, 25 and 30 cm heads, another pattern of relationship could be detected between the variable head and the corresponding discharge values, where the lowest discharge values (19.69 , 28.96 and 39.68 L s^{-1}) were recorded for the cutthroat flume. The highest values (42.86 , 59.17 and 77.00 L s^{-1}) were recorded for the rectangular weir. The discharge values recorded for the v-notch (23.7 , 40.68 and 63.25 L s^{-1}) came in between. The aforementioned results illustrate that the rectangular weir is the best one for measuring water discharge, where under the different studied heads, it gave the highest discharge values. This finding confirms the previously attained which revealed that the rectangular weir is more accurate at the high rates of discharge.

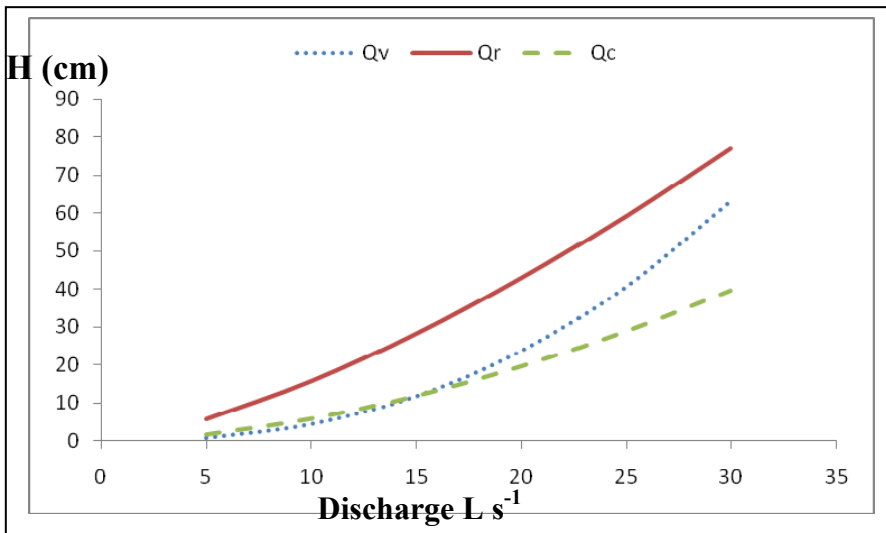

Figure (17): Head-discharge relation for v-notch weir, rectangular weir and cutthroat flume.

Field applications:

The v-notch and the rectangular weir devices were used under Kafer El Sheik Governorate conditions and the results showed that water conveyance efficiency for improved mesqas ranged from 95.54% to 98.03%, while for unimproved mesqas it ranged from 90.55 to 89.62%.

SUMMARY AND CONCLUSION

Different devices, v-notch, rectangular weir and cutthroat flume are used for measuring water flow in open channels. However, the most accurate to be used is not certain. Water flow measuring-devices and hydraulic structures with different degrees of accuracy were tested and calibrated in this research.

The selected devices were calibrated in the Hydraulics Research Institute Laboratory in Qanatir City (Egypt), by using ultrasonic flowmeter under different discharges of 5, 10, 15, 20, 25, 30 and 35 L s⁻¹.

Results showed that under discharges (5 L s⁻¹ and 10 L s⁻¹), the most accurate device was the v-notch, while under discharges (15, 20, 25, 30 and 35 L s⁻¹) the most accurate one was the rectangular weir. Increasing discharge rate from 5 to 35 L s⁻¹, resulted in increases in error % in the readings of the v-notch. On the other hand, the corresponding error % in readings of both of rectangular weir and the cutthroat flume obviously decreased. The decreases seemed inversely related to the rate of discharge.

From the aforementioned discussion, the v-notch is preferable for measuring the discharge at a rates ranging from 5 to 10 L s⁻¹, beyond which the rectangular weir as well as the cutthroat flume would be preferable.

The readings of the cutthroat flume were more accurate at time intervals of 20 min in the average.

The most accurate devices were tested under Kafer El Sheik Governorate conditions and the results showed that water conveyance efficiency for improved mesqas ranged from 95.54% to 98.03%, while for unimproved mesqas the conveyance efficiency ranged from 90.55 to 89.62%

Recommendations

- v-notches are recommended for use under low discharges, while under high discharges rectangular weirs are more accurate
- All water flow measuring devices must be calibrated before using.
- Measurements showed water saving due to improved channels over unimproved ones in "Kafr El Sheikh" scheme conditions.
- Water flow-measuring devices help farmers to know the appropriate water-application duration required for a certain area.

REFERENCES

- ASTM, (2003) D5640:** Standard guide for selection of weirs and flumes for open-channel flow measurement of water. Ann. Bk. of ASTM standards, Vol. 11.02, <http://www.techstreet.com/cgi-bin/>
- Bos, M.G., Replogle, J.A. and Clemmens, A.J. (1985):** Open channel flow measurement: 141 pp., <http://www.leeds.ac.uk>
- Cuttle, S.P. and Mason, D.J. (1987):** A flow-proportional water sampler for use in conjunction with a **v-notch** weir in small catchment studies. Agric. Water 13:93-99.
- Farag, A. A. (2007):** Evaluation of water flow measurement methods appropriate for on-farm management in Egypt Dept. Agri. Eng. Fac. Ag. Benha U., Egypt.
- Kulin, G., and P.R. Compton (1975):** "A guide to methods and standards for the measurement of water flow." Nat. Bur. of standards, spec. publ.: 421.
- LMNO Engineering, (2001):** The fluid flow calculations website. <http://www.LMNOengeneering.com>
- Pugh, C. A. (2001):** Using reclamation's new "Water measurement manual" to save water. U.S. Dep. of the Interior, Bureau of Recl., Denver, Colorado. www.usbr.gov
- Replogle, J. A. (1998):** Measuring flows in earthen canals and irrigation wells. Issue of Irrigation J.: <http://www.greenmediaonline.com/ij/1998/0398/0398mf.html>
- Replogle, J.A. (1971):** Critical-depth flumes for determining flow in canals and natural channels. Trans. ASAE No. 70-215: 428-433.
- Replogle, J. A. and Clemmens, A. J. (1979):** Broad-Crested weirs for portable flow metering. Transactions of the ASAE, pp. 1324-1328.
- Swamee, B. K. S. (1988):** Rectangular weir equation. A.S.C.E. Vol.114, No. 8, pp. 945-949.
- USBR, (2001):** Water measurement manual. U.S.D of Interior, Bur. of Recl. 3rd ed. Available from <http://www.ntis.gov>
- Walker, W.R. (1989):** Guidelines for designing and evaluating surface irrigation systems. FAO irrigation and drainage paper 45.

الملخص العربي

تقييم طرق قياس السريان المائي المناسبة لإدارة الري الحقل في مصر

محمد يوسف الإنصاري^١ منتصر عبد الله عواد^٢ عاطف عبد الغفار نصار^٣
أبو سريع أحمد فرج^٤

يهدف البحث الى:

- ١- اختبار ومعايرة بعض أجهزة قياس سريان المياه المناسبة لإدارة الري الحقل في مصر.
- ٢- إستخدام الجهاز الأكثر دقة في قياس كفاءة نقل المياه في مسقة مبطنة وأخري غيرمبطنة (ترابيه).

أجهزة قياس السريان

أ-أجهزة قياس السريان في القنوات المفتوحة .

١. هدار مثلث (من الخشب قائم الزاوية ، عرض الهدار ٧١.٥ سم ، ارتفاع العتب ١٦.٥ سم ، و ارتفاع الهدار ٤٣.٥ سم).
٢. هدار مستطيل (من الخشب عرض ٦٣.٥ سم ، و عرض العتب ٢٦.٨ سم ، وارتفاع العتب ١٥.٦ سم ، وارتفاع الهدار ٥٣ سم).
٣. المضيق قصير الزور (Cutthroat Flume) (مصنوع من الياف الزجاج - الفيبرجلاس ، عرض زوره ١٠ سم ، وطوله ٩٠ سم ، وارتفاعه ٤٧ سم).

ب- أجهزة قياس السريان في القنوات المغطاة (المواسير):

١. جهاز قياس السريان باستخدام الموجات فوق الصوتية Ultrasonic Flowmeter وهو أدق الأجهزة ولذلك تم إستخدامه في عمل إختبار ومعايرة للأجهزة السابقة.
- ج-أجهزة مساعده (مقياس الضاغط وميزان المياه):

تم أخذ متغيران: الأجهزة والتصرف، وتم تقدير الضاغط بإستخدام المقياس الخاص بالضاغط ، والسرعة باستخدام مقياس التيار لدراسة أداء الأجهزة المختارة تحت التصرفات المختلفة. تم أخذ ٨ قراءات ضغط لكل تصرف علي فترات زمنية من ٥ الى ٤٠ دقيقه. وذلك لتقدير التصرف ومقارنتها بقراءة جهاز ultrasonic flow meter وذلك لكل جهاز علي حدة تحت تصرفات من ٥ الى ٣٥ لتر / ث، وتحديد الجهاز الأكثر دقة. تم قياس السرعة مع كل جهاز وذلك علي النحو التالي: بالنسبة للهدار المستطيل والهدار المثلث تم أخذ قطاعان للسرعة ، إحداها عند مسافة ١٢٠سم (عند مكان أخذ قراءة الضاغط) والآخر عند فتحة الهدار مباشرة. بالنسبة للمضيق فتم أخذ ثلاثة قطاعات للسرعة ، عند منسوب الأمام ، وعند الزور ، والأخير (downstream) . تم تقسيم كل قطاع رأسي إلي خمسة قطاعات أفقية: عند السطح والى ٨٠% من العمق .

١- أستاذ الهندسة الزراعية - قسم الهندسة الزراعية - كلية الزراعة بمشهر - بنها.

٢- أستاذ الهندسة الزراعية المساعد - قسم الهندسة الزراعية - كلية الزراعة بمشهر - بنها.

٣- باحث أول بمركز القومي للمياه - معهد بحوث إدارة المياه.

٤- مدرس مساعد - قسم الهندسة الزراعية - كلية الزراعة بمشهر - بنها.

التطبيق الحقلى

تم التطبيق فى قناتين إحداهما مبطنه (١٦١.٧ م) والأخرى غير مبطنه (١٢٠ م) وذلك لقياس كفاءة نقل المياه .

أهم النتائج :-/أوضحت نتائج الدراسة أن

- ١- أدق الأجهزة عند تصرف ٥ لتر/ث و ١٠ لتر /ث هو الهدار المثلى وعند تصرفات من ١٥ الى ٣٥ لتر /ث كان الهدار المستطيل هو الأدق .
- ٢- معامل التصرف للهدار المثلى يتراوح بين ٠.٥٥٣ و ٠.٥٩٩ ، وبالنسبة للهدار المستطيل تتراوح بين ٠.٦١٥ و ٠.٦٦٦ ، وبالنسبة للمضيق بين ٠.٢١٢ و ٠.٢٦١ .
- ٣- أنسب معادلة للهدار المثلى تحت ظروف البحث كانت كالتالى:

$$Q_v = 0.0168 H^{2.4208}$$
- ٤- أنسب معادلة للهدار المستطيل تحت نفس الظروف كانت:

$$Q_v = 0.0168 H^{2.4208}$$
- ٥- أنسب معادلة للمضيق تحت نفس الظروف:

$$Q_c = 0.1116 H^{1.7286}$$
- ٦- أنسب معادلة لحساب نسبة الخطأ فى القراءة للهدار المثلى:

$$E_v \% = - 0.0214 Q^2 + 0.9762 Q - 5.1714$$
- ٧- أنسب معادلة لحساب نسبة الخطأ فى القراءة للهدار المستطيل تحت الظروف:

$$E_r \% = - 0.016 Q^2 + 0.7944 Q - 10.714$$
- ٨- أنسب معادلة لحساب نسبة الخطأ فى القراءة للمضيق تحت الظروف:

$$E_c = 0.0097 Q^2 - 1.061 Q + 17.004$$
- ٩- فبالنتيجة الحقلية اظهرت النتائج أن كفاءة نقل المياه تكون أكبر فى حالة القنوات المبطنة (٩٥.٥٤% و ٩٨.٠٣%) عنها فى حالة القنوات غير المبطنة (٩٠.٥% و ٨٩.٦٢%).

التوصيات :-

- ١- يفضل استخدام الهدار المثلى مع التصرفات المنخفضة والهدار المستطيل مع التصرفات الكبيرة.
- ٢- يجب معايرة كل أجهزة قياس السريان قبل استخدامها فى القياس .
- ٣- يجب نشر القنوات المطورة محل القنوات غير المبطنة لما لها من مزايا عديدة.
- ٤- لاهتمام بقياس السريان فى معرفة كمية المياه التي تم إضافتها للحقل ونسب الفقد.